

# s15404

**ENVOYÉ PAR**  
Operateur 4 Servisco  
opérateur4@servisco.be

---

**CRÉÉ LE**  
2022-12-06



<b>Surface totale</b> 1221.84 m <sup>2</sup>	<b>Étages</b> 1	<b>Pièces</b> 5	<b>Salle de bain</b> 0
---	--------------------	--------------------	---------------------------

▼ Rez-de-chaussée

SURFACE TOTALE : 1221.84 m<sup>2</sup> • SURFACE HABITABLE : 19.51 m<sup>2</sup> • PIÈCES : 5

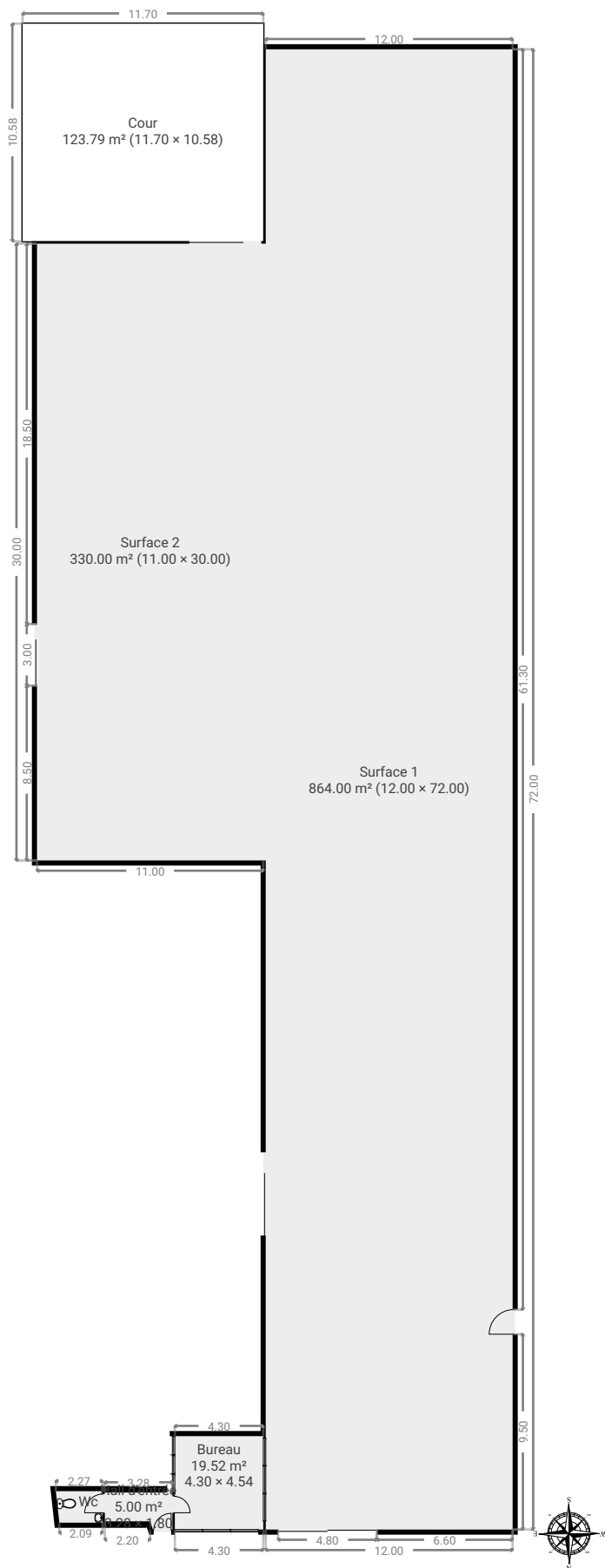

▼ **Bureau**  
Rez-de-chaussée

LARGEUR : 4.30 m • LONGUEUR : 4.54 m  
SURFACE : 19.52 m<sup>2</sup> • PÉRIMÈTRE : 17.68 m

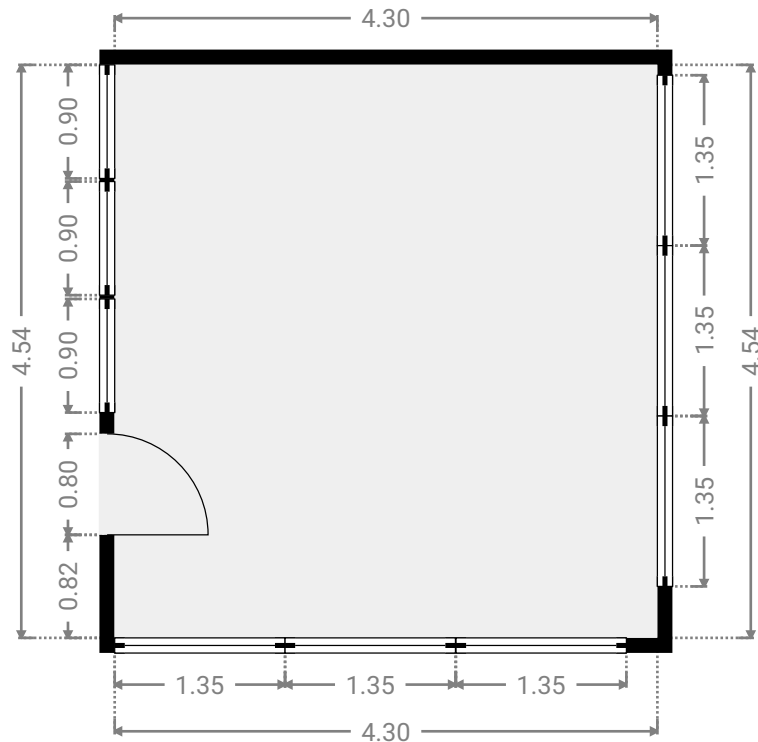

▼ **Hall d'entrée**  
Rez-de-chaussée

LARGEUR : 3.28 m • LONGUEUR : 1.80 m  
SURFACE : 5.00 m<sup>2</sup> • PÉRIMÈTRE : 10.05 m

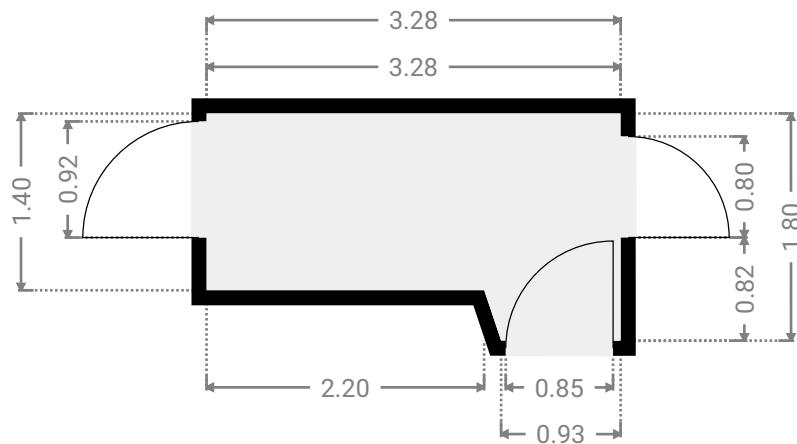
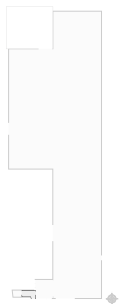

▼ **Surface 1**  
Rez-de-chaussée

LARGEUR : 12.00 m • LONGUEUR : 72.00 m  
SURFACE : 864.00 m<sup>2</sup> • PÉRIMÈTRE : 168.00 m

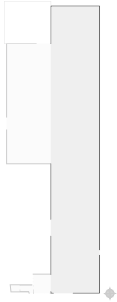

▼ **Surface 2**  
Rez-de-chaussée

LARGEUR : 11.00 m • LONGUEUR : 30.00 m  
SURFACE : 330.00 m<sup>2</sup> • PÉRIMÈTRE : 82.00 m

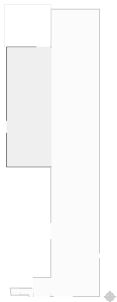

▼ **Cour**  
Rez-de-chaussée

LARGEUR : 11.70 m • LONGUEUR : 10.58 m  
SURFACE : 123.79 m<sup>2</sup> • PÉRIMÈTRE : 44.56 m

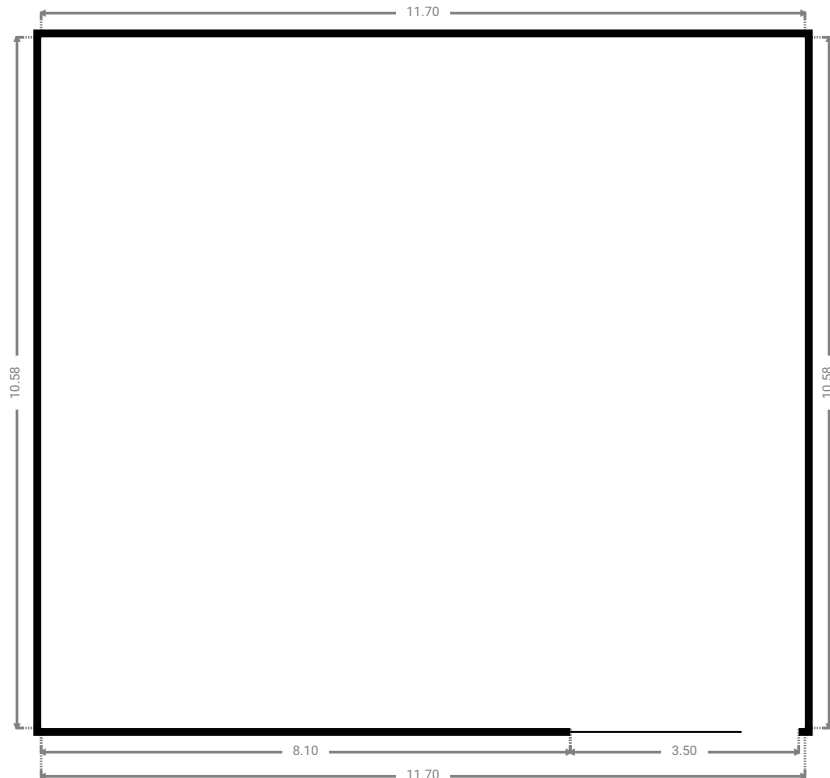

▼ **Wc**  
Rez-de-chaussée

LARGEUR : 2.26 m • LONGUEUR : 1.53 m  
SURFACE : 3.33 m<sup>2</sup> • PÉRIMÈTRE : 7.43 m

